

User Manual CGM MP-1101

Hi/Lo Projector System
Convenient Portability & Innovative Design
The Future of Bio-Technologically Advanced Heat Source Systems
A Projector System that Targets Acupuncture Pressure Points on the Body







Important Safety Guidelines

For your safety, read this manual before usage and store in a safe place.

The cautions below are for the safety and protection of the user and to prevent product damage.

Read the manual carefully for appropriate usage.

The safety guidelines are categorized as the following

 Danger	High possibility of serious injury or death if instructions are violated.
 Warning	Possibility of serious injury or death if instructions are violated.
 Caution	Possibility of minor injury or product damage if instructions are violated.

Danger Follow the instructions below in order to reduce the risk of electric shock.

- Do not use this product with pins or other metals.
- Do not use where there is humidity or water.
- The external projector must be used with the external projector cover.
Direct contact with this product and the skin may result in burns.
- Do not use the external projector on or around the eyes.
- In order to avoid electric shock or burns,
make sure hands are dry and do not tug on the cord when unplugging.
- Discontinue usage in case of thunder, lightning, or earthquake.

Warning

- Apart from the external projector cover provided by the manufacturer,
do not place any other objects or substances such as fibrous products or blankets on top of the product,
as this may cause fire.
Use this product according to the instruction manual.
- Do not use this product with components which have not been provided by the manufacturer.
- Children must be supervised by an adult when using this product. Keep out of reach of children.
- Patients with malignant tumor, high fever, low energy, allergies, sensitive reactions,
or on life support should consult their physician before using this product.
- Do not use this product in toxic or chemically imbalanced environments.



Important Safety Guidelines

- Call the customer center and request inspection or after-service if :
 - the product has been dropped or damaged
 - the product came in contact with liquids
 - the cord or power button is damaged
 - the product is dysfunctional"
- Keep the power cord away from electric heating appliances or heaters.
- Do not attempt to dismantle, alter, or repair the product.
Contact the store of purchase or service center when in need of repair.
- In order to avoid the risk of burns,
do not leave the projector on one part of the body for more than 5 minutes at a time.
- In order to avoid bodily injury or product damage, do not step or stand on top of the product.
- Do not use the product on top of any heating devices including heating mats.

Caution

- Keep the product unplugged when not in use.
- Setting the product on a high temperature can increase the risk of burns, especially for children or those who have sensitive skin.
- In order to reduce the risk of burns, adults and children who have weak, sensory skin or those who are incapable of controlling the temperature must be cautious when using this product for an extended period of time.
- If any abnormal symptoms arise while using this product, discontinue usage immediately and consult your physician.
- Do not forcibly bend the power cord or outer wiring. This may cause electric shock or fire.
- Keep this product away from flammable objects (candles, cigarettes, alcohol) and liquids.
Do not place heavy or sharp objects on top of this product.
- It is recommended that the product not be used more than 1-3 times per day.
- Do not apply any force to the product.
- Check voltage before product installation. (There is a risk of product damage or fire.)
- Do not tug on the cable while using the external projector. (This may cause cable damage.)
- Do not apply excessive force to the external projector. (This may cause product damage.)
- Children should be supervised by an adult when using this product.
- This product has a heated surface.
To avoid bodily injury or burns, persons insensitive to heat should not use this device.
- Be cautious when utilizing the storage compartments. There is a risk of finger or bodily injury.

Contents

>> Important Safety Guidelines	02
- Danger	
- Warning	
- Caution	
1. Product Introduction	05
- Features	
- Components	
- Functions	
2. Installation & Product Use	10
- Installation	
- Product use	
- Manual Mode	
- Auto Mode	
- Product Display Codes	
3. Maintenance & A/S	16
- Self-inspection Checklist	
- Product Maintenance & Specifications	
- Product Warranty	
4. Appendix	20

This appliance is not intended for use by persons (including children) with reduced physical, sensory or mental capabilities, or lack of experience and knowledge, unless they have been given supervision or instruction concerning use of the appliance by a person responsible for their safety.

I . Product Introduction

1. Features
2. Components
3. Functions



1. Features

- Convenient Portability & Innovative Design
- User-Friendly Interface
- Use of medical connector through a One touch method
- Hi/Lo Projector System for Pressure Control
- Temperature control on a 1°C scale
- Bio-Technologically Advanced Heat Source System
- Energy Saving, Long life LED
- Projector System that Targets Acupuncture Pressure Points on the Body.





2. Components

- 9-Sphere projector



- Abdominal Belt

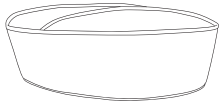

- Height Adjustable Support



- Projector Cover

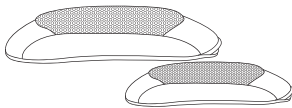

- Power Cable

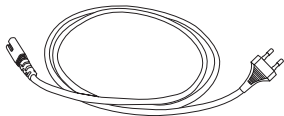

- Pressure Point Application Guide
- User Manual
- Sub-Manual

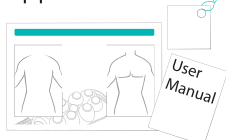

- 3-Sphere projector

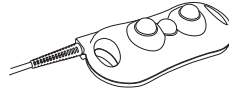

- Dust Bag



- Main body





3. Functions

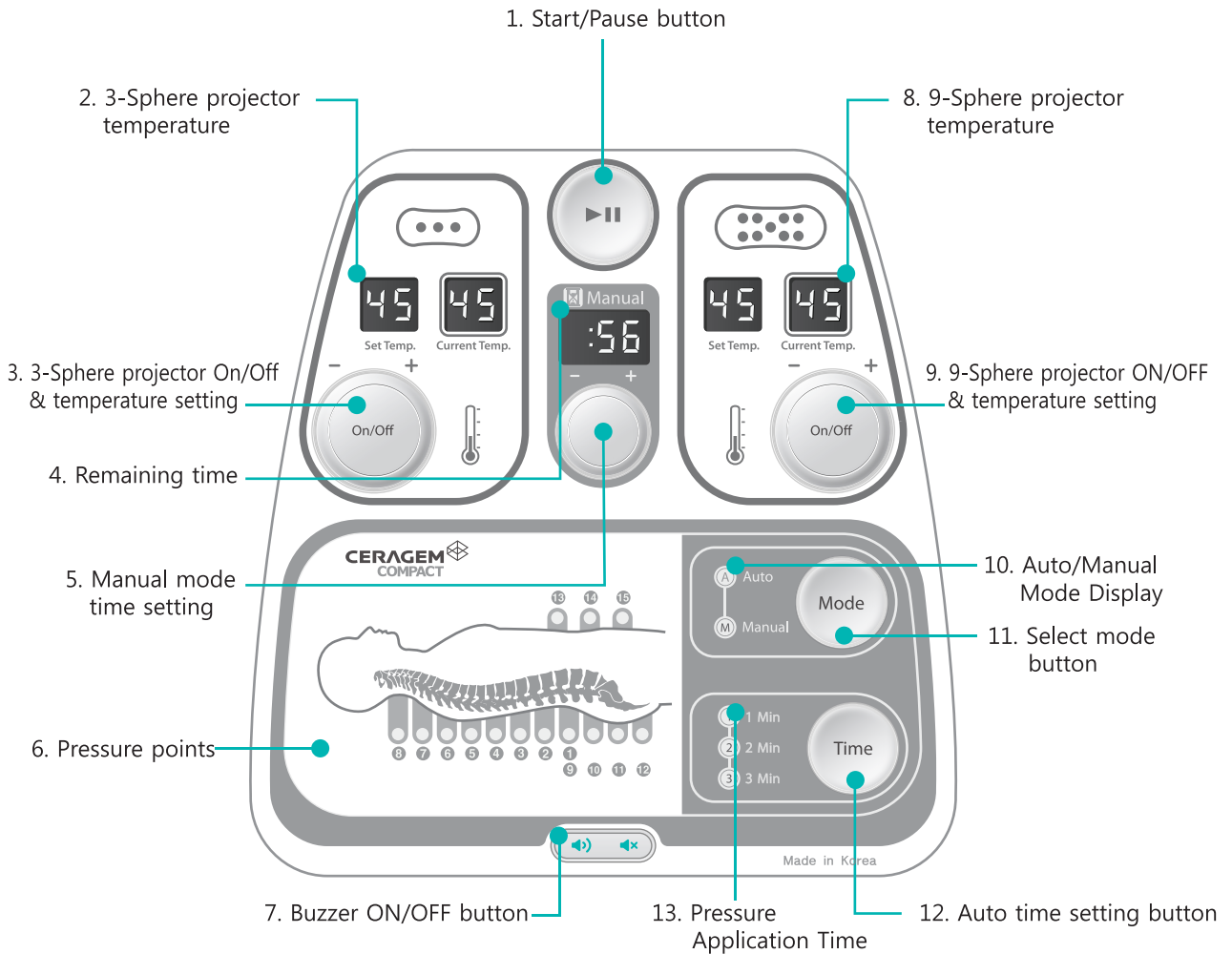



3.1 Functions

1	Start/Pause button	A button that starts/pauses the product operation
2	3-Sphere projector temperature	Shows the 3-Sphere current temperature and the set temperature
3	3-Sphere projector On/Off & temperature setting	A button that can turn the 3-Sphere projector ON/OFF and a dial that can set the temperature from 30~60°C
4	Remaining time	Shows the time left for Manual mode / Auto mode
5	Manual mode time setting	A dial that can set Manual mode from 5 minutes to 2 hours.
6	Pressure points	Shows the pressure point during Auto mode
7	Buzzer ON/OFF button	A button that can set the buzzer on ON or OFF
8	9-Sphere projector temperature	Shows the 9-Sphere projector's current temperature and the set temperature.
9	9-Sphere projector On/Off & temperature setting	A button that can turn the 9-Sphere projector ON/OFF and a dial that can set to temperature from 30~60°C
10	Auto/Manual Mode Display	Shows the current mode being operated
11	Select mode button	A button that can select Auto/Manual mode
12	Auto time setting button	A button that can select pressure time to 1, 2 or 3 minutes when operating Auto mode
13	Pressure Application Time	Auto mode pressure time

II. Installation & Product Use

1. Installation
2. Product Use
3. Manual Mode
4. Auto Mode
5. Product Display Codes





1. Installation



Caution

- Install the product on a flat surface.
- Avoid installation in humid or dusty areas.

1

Open the storage box and remove the 9-sphere projector, 3-sphere projector, and the product cable.

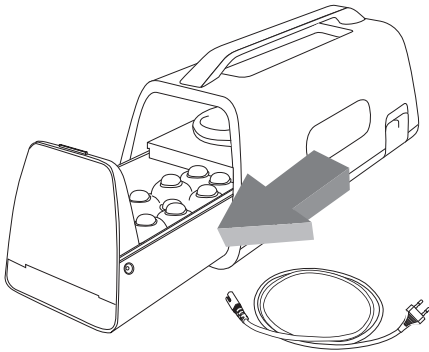

2

Connect the external projectors to the allocated sockets on either sides of the product.

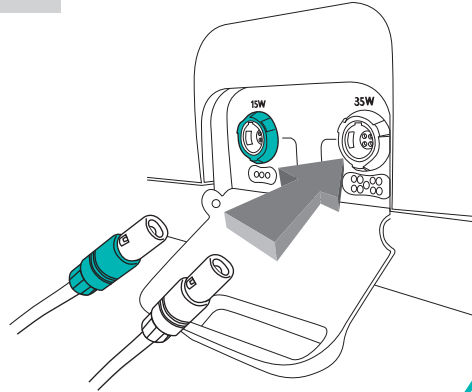

9-sphere and 3 sphere projectors must be plugged in before usage.



Warning

Do not touch the connector pin() as doing so may cause injuries or damage the product.

3

Connect the power plug to the right side of the product.

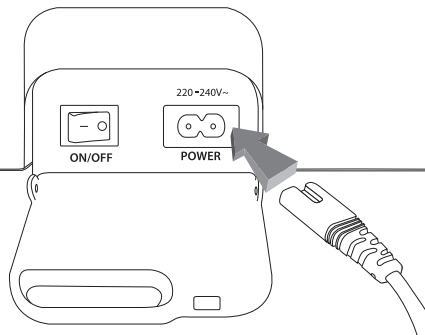

4

Plug the cord into an electrical outlet.

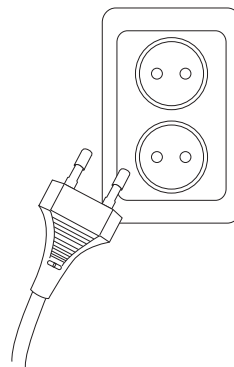

Caution

Plugging in the product while the power switch is ON may cause malfunction.



2. Product Use

1

Click the power switch located on the right side of the product to turn the power on.

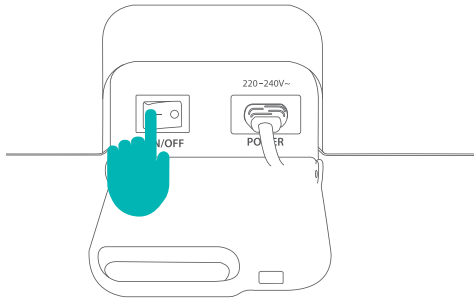

2

Once the LED light on the Start/ Pause button has lit up, press it to start the program.

(Default: auto mode)

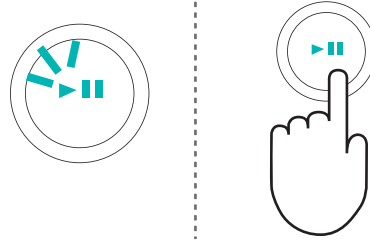

3

Use the ON/OFF button to control the sound.
(Applicable to both Auto/Manual modes)

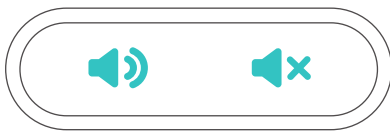

4

Turn the temperature setting dial from 30~60°C to set the projector's temperature.
(Applicable to both Auto/Manual modes)

Control the power using the ON/OFF button on the external projectors.

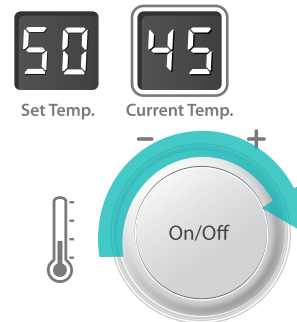

5

Pausing the Product

1. Press the Start/Pause button to pause at anytime during usage.
 2. When in the Pause mode, the time indicator will flicker on and off.
 3. Other buttons will not be functional while in Pause mode.
 4. Press the Pause button to resume the program.
- The product will turn off automatically after 10 minutes in Pause mode.



3. Manual Mode

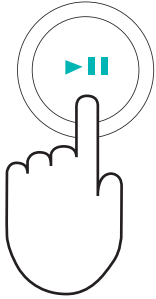

- 1** Once the product has been switched on, press the Start/Pause button.



- 2** Manual Mode operates from 5 ~ 120 minutes. The product will shut down automatically once the set time has passed.

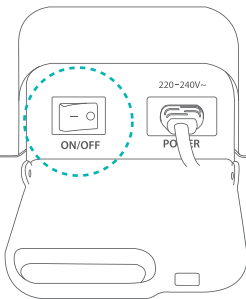

- 3** To restart the product, press the Start/Pause button and repeat steps 1 and 2.
- 4** When you have finished using the product, turn the power switch off.

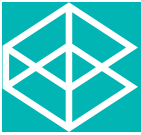

4. Auto Mode

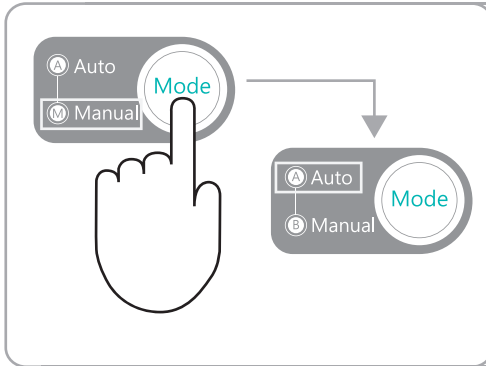

- 1** You can switch to Manual Mode during Auto Mode by pressing the Mode button.

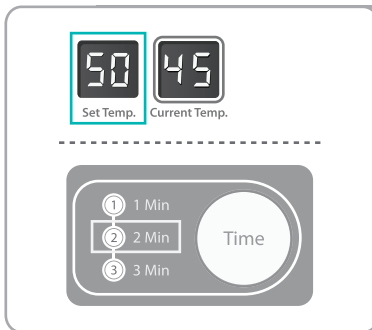



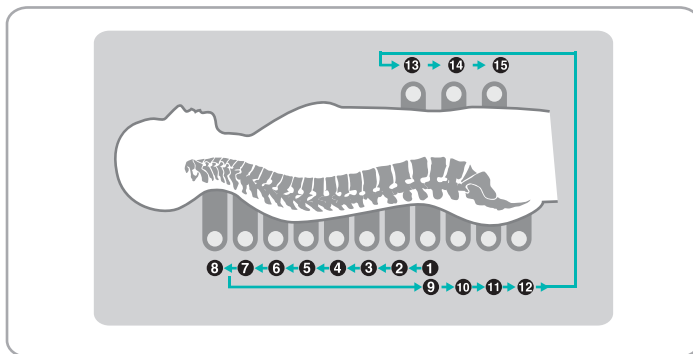

- 2** The projector will automatically revert back to the last set temperature and pressure time. The temperature can be set between 30~60°C and the pressure time can be set to 1, 2, or 3 minutes according to the user.



- 3** The light along the pressure points 1~15 will advance according to the set time.
- 4** You can switch to Manual Mode during Auto Mode by pressing the Mode button



5. Product Display Codes

Codes	Description
tH	 <ul style="list-style-type: none">■ The projector's temperature has exceeded the maximum setting temperature (60°C) by more than 10°C. The buzzer will go off twice every second for 5 seconds, and the product will automatically shut down■ Contact your local manufacturer's parts and service center for inspection or repair
-9	 <ul style="list-style-type: none">■ The projector's temperature is below -10°C■ The projector will begin to function properly as it heats up
SE	 <ul style="list-style-type: none">■ Internal sensor problem. Buzzer will go off twice every second for 5 seconds, and the projector will automatically shut off■ Contact your local manufacturer's parts and service center for inspection or repair
PH	 <ul style="list-style-type: none">■ The main body temperature is higher than 80°C. The buzzer will go off twice every second for 5 seconds, and the product will automatically shut down■ Contact your local manufacturer's parts and service center for inspection or repair
CH	 <ul style="list-style-type: none">■ The projector's electrical current has exceeded the normal amount. The buzzer will go off twice every second for 5 seconds, and the projector will automatically shut off■ Contact your local manufacturer's parts and service center for inspection or repair

III. Maintenance

1. Self-Inspection Checklist
2. Product Maintenance &
Specifications
3. Product Warranty





1. Self-Inspection Checklist

Self-inspection Checklist before use

- Is the power cord plugged into a socket? (Have you checked whether the product is "ON"?)
- Is the external projector fixed to the main body?
- Is the LED on the "Start/Pause" button working?
- Is the temperature window on?
- Has the projector been set to an optimal temperature of 45~55°C?
- Has the buzzer ON/OFF LED been turned on?
- Are the external projectors' LEDs turned on?
- Does the external projector's jade become hot?
- Check for damages to the external projector cover.

Self-inspection Checklist after use

- Are all of the display windows off?
- Is the external projector's LED off?
- Is the power button OFF?
- Has the power cable been unplugged?

Before Requesting A/S

Q1: Is the product not functioning properly?

The power does not turn on. _____ Check to see if the power cord is connected.
(power failure) _____ Check to see if the power button is 'ON'.

Try plugging the product into a different electrical outlet.

The product turns off by itself during use. _____ Disconnect and reconnect the power cord.

The buttons do not work. _____ Disconnect and reconnect the power cord.
_____ Disconnect and reconnect the external projector.

The buzzer does not ring. _____ Try pressing the buzzer button to check for sound.

Q2: Is the external projector dysfunctional?

Is the external projector properly connected? _____ Reconnect the external projector.

_____ Disconnect and reconnect the power cord.



2. Product Maintenance and Specifications

Product Maintenance

- Avoid direct sunlight and humidity. (May cause discoloration and damage)
- Store indoors at room temperature.
- Serious damage and injury can occur if the product comes in contact with flammable objects.

Product Specifications

Model name	CGM MP-1101
Product name	Thermal Acupressure Device
Rated voltage	220-240V~, 50/60Hz
Fuse	250V, 1.6A
Power consumption	Max 110VA
Usable temperature	30°C - 60°C
Cable size	Power cord cable : 1,830mm External projector cable : 2,700mm
Product measurement	Main body : 551mmx216mmx249mm(±10mm) 9-Sphere projector : 302mmx132mmx65mm(±10mm) 3-Sphere projector : 230mmx101mmx65mm(±10mm)
Weight	Main body : 3.87Kg(±0.1Kg) 9-Sphere projector : 0.86Kg(±0.1Kg) 3-Sphere projector : 0.52Kg(±0.1Kg)
The purpose of use	Help to muscle relaxation therapy, temporary relief of minor muscle and joint pain, stiffness, blood circulation.
Manufacturer/ Country of manufacture	Ceragem/Republic of Korea
This product is a "Medical Device".	



3. Product Warranty

Warranty Certificate

- ▶ This product is under the warranty as governed by the Consumer Protection Act.
- ▶ This warranty shall not be reissued.
- ▶ Contact the retailer or the nearest service center when you experience any trouble with the product.
- ▶ The Company stocks the parts for this product for 3 years after the date of final production (5 years for key parts).

Article	Thermal Acupressure Device	Model	CGM MP-1101
Warranty Period	1 year after the date of purchase	Serial Number	
Date of purchase	20 , , ,	Name of Retailer	

Warranty Services

The Company provides warranty repair services, free of charge, for one year after the date of purchase and only when the product has been used according to the guidelines.

■ The warranty period may be shortened to half a year when the product has been used for commercial purposes.

Chargeable Services

- A service fee will be charged if the defect is caused by user negligence.
- If the defect is caused by natural disasters, the Company will charge the net repair cost.
- Consumables will be replaced at cost.

CERAGEM CO., LTD.
 177-14 Osaekdang-ri, Seonggeo-eup, Seobuk-gu,
 Cheonan-si, Chungcheongnam-do, [331-831] Korea
 Tel : 82-41-523-2550 Fax : 82-41-523-2560

EC REP CERAGEM EUROPE GMBH
 Mergenthalerallee 25, D-65760 Eschborn, GERMANY
 Tel : 49-6196-887-7780 Fax : 49-6196-887-7770



This marking shown on the product or its literature, indicates that it should not be disposed with other household wastes at the end of its working life. To prevent possible harm to the environment or human health and recycle it responsibly to promote the sustainable reuse of material resources.

Household users should contact either the retailer where they purchased this product, or their local government office, for details of where and how they can take this item for environmentally safe recycling.

Business users should contact their supplier and check the terms and conditions of the purchase contract.

This product should not be mixed with other commercial wastes for disposal.

IV. Appendix



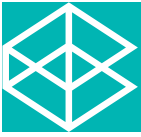

Classification

- Type of protection against electric shock : Class II equipment
- Degree of protection against electric shock : Not classified-B applied parts
- Classification according to the degree of protection against ingress of water : IPX0, ordinary equipment
- This equipment is not suitable for use in the presence of flammable anesthetics or oxygen
- Mode of operation : continuous operation



Be careful of eye damage caused by a height adjustable support.

Information to the use

- This equipment has been tested and found to comply with the limits for medical devices in IEC/EN 60601-1-2. These limits are designed to provide reasonable protection against harmful interference in a typical medical installation.
This equipment generates, uses and can radiate radio frequency energy and, if not installed and used in accordance with the instructions, may cause harmful interference to other devices in the vicinity. However, there is no guarantee that interference will not occur in a particular installation.
If this equipment does cause harmful interference to other devices, which can be determined by turning the equipment off and on, the user is encouraged to try to correct the interference by one or more of the following measures:
 - Reorient or relocate the receiving device.
 - Increase the separation between the equipment.
 - Connect the equipment into an outlet on a circuit different from that to which the other device(s) are connected.
 - Consult the manufacturer or field service technician for help.
- **WARNING :** Do not touch signal input, signal output or other connectors, and the patient simultaneously.
WARNING : External equipment intended for connection to signal input, signal output or other connectors, shall comply with relevant IEC Standard(e.g., IEC60950 for IT equipment and IEC60601-1 series for medical electrical equipment).
In addition, all such combination-system-shall comply with the standard IEC60601-1 and/or IEC60601-1-1 harmonized national standard or the combination. If, in doubt, contact qualified technician or your local representative.



Maintenance and Storage

- Moisture must be removed immediately with a dry towel as the surface of the product may peel off when in direct contact with cosmetics or flammable substances for an extended period of time.
- Hand-clean the projector cover using a neutral detergent
- Treat with extra care near hot objects and flammable object as the projector cover may cause a fire.
- Avoid direct sunlight or humid places as they may cause decolorization and aging of the product
- Keep in room temperatures
- Do not wash in hot water. Do not use bleach.
- Always wipe with wet cloth those parts of the unit that come in direct contact with human body. Wipe out any moisture with a dry towel.

Environmental conditions

Operating condition	Temperature	-30℃~70℃
	Relative Humidity	10~90%
	Atmospheric Pressure	700~1060hPa
Transport & Storage Condition	Temperature	-30℃~70℃
	Relative Humidity	10~95%
	Atmospheric Pressure	1060hPa

Power supply Specifications

Manufacturer	Fine powerex
Model Name	C931E220
Power consumption	Max 110VA
Rated voltage	220-240V~, 50/60Hz

MEMO

A series of horizontal dashed lines for writing.

MEMO

A series of horizontal dashed lines for writing.

MEMO

A series of horizontal dashed lines spanning the width of the page, providing a template for handwritten notes.

CERAGEM 

 **CERAGEM CO., LTD.**
177-14 Osaekdang-ri, Seonggeo-eup,
Seobuk-gu, Cheonan-si, Chungcheongnam-do, Korea
Tel : (82)41-523-2550 Fax : (82)41-523-2560

EC REP CERAGEM EUROPE GMBH
Mergenthalerallee 25, D-65760 Eschborn, GERMANY
Tel : 49-6196-887-7780 Fax : 49-6196-887-7770



Deposit of Old Electrical
& Electronic Equipment
Applicable in the European
Union and other European
countries with separate
collection systems.